

G25 and G40

Diaphragm Meters

Through decades of knowledge in the field of commercial and industrial diaphragm gas meters, our G25 and G40 meter sizes combine accuracy of measurement and long life in the field.



Application

The G25-G40 diaphragm meters are used for applications requiring high precision and large rangeability at low pressure (below 1 bar gauge).

Due to the volumetric principle of the diaphragm meter, its metrology is not influenced by installation conditions.

They are designed for use with natural gas, manufactured gas and other non-corrosive gases.

The G25-G40 diaphragm meters are approved for fiscal use.

Operating Principle

The movement of the diaphragm is caused by the pressure difference between the inlet and the outlet of the meter. The reciprocal filling is controlled by means of 2 sliding valves.

This oscillating movement is transformed into a rotational one and is mechanically transmitted to the totalizer through a magnetic coupling or a stuffing box.

KEY benefits

- » Ready for remote reading and data management
- » Long-term accuracy and reliability
- » Very low pressure loss
- » Robust, maintenance-free meter
- » Large cyclic volumes

Typical Error Curve

G25 (Two Pipe DN50)

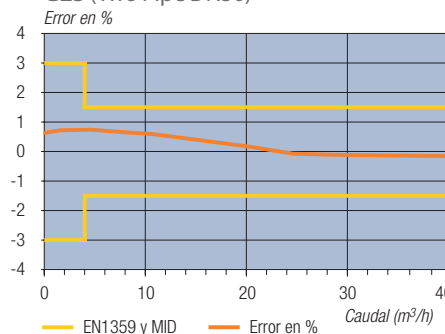

G40 (Two Pipe DN80)

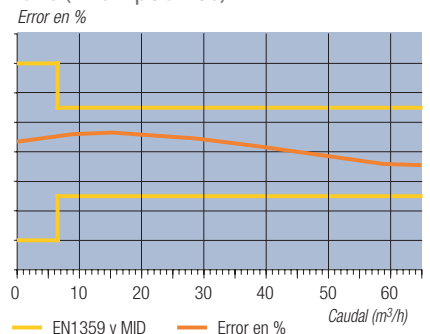

Pressure Loss Curve

G25

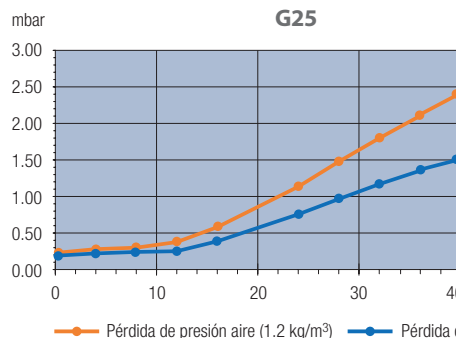

G40

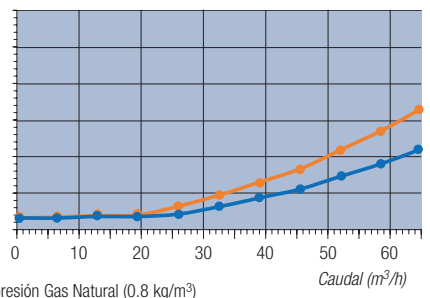

Construction

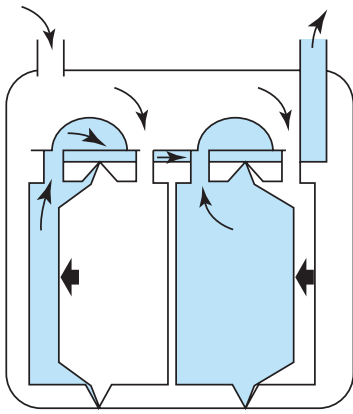

Working Principle

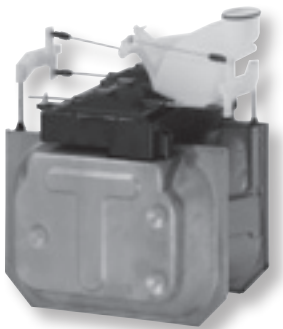

Measuring Unit

A diaphragm meter is made of four main parts:

- 1 The measuring unit mainly consisting in:
 - » Four measuring chambers.
 - » Two sliding valves.
 - » An outlet pipe.
- 2 A steel casing where 1 or 2 connectors are fitted.
- 3 A magnetic coupling or a stuffing box transmits the movement of the measuring unit to the totalizer.
- 4 A totalizer is available in different versions depending on the application

Technical Specifications

Gas Type	Natural Gas, air, propane, butane, nitrogen and all non-corrosive gases		
Cyclic Volume	G25:	20 dm ³	
	G40:	30 dm ³	
Temperature Range	Ambient:	-25°C to +55°C	
	Gas:	-25°C to +55°C	
	Storage:	-40°C to +70°C	
Maximum Working Pressure	0.5 bar (1 bar optional)		
Flow Range	G25:	Qmin	0.25 m ³ /h
		Qmax	40 m ³ /h
	G40:	Qmin	0.4 m ³ /h
		Qmax	65 m ³ /h
Accuracy	Class 1.5		
Approval	MID (04/22/EC) module B, DE-10-MI002-PTB004, and EN 1359:2017		
Metrology	In accordance with the EN 1359:2017 and MID Maximum permissible errors are +/-3% from Qmin to 0.1 Qmax and +/-1.5% from 0.1 Qmax to Qmax.		
Totalizer	IP54		
	UV resistant cover		
	Fitted with a reflecting disc on the first drum to facilitate periodical checks Customised name plate: bar code, customer serial number or logo		
Magnetic Coupling Stuffing Box	The meter is equipped as standard with a magnetic coupling As an alternative a stuffing box can be also installed		
Connections	Single pipe or 2 pipe connections From DN40 to DN80 depending on the G-size Vertical connections for the G25, vertical or horizontal for the G40 Other connections are available on request		
Backrun Stop	Prevents the meter from running backwards in case of tampering		
Materials	Steel sheet, drawn or welded depending on the G-size. The use of a powder-coated painting guarantees long term protection against corrosion. All the casings are of a screw type to allow easy maintenance on the meter – no crimped casing		
Colour	Light grey RAL7035		

Options

Thermowell	The meters can be fitted with a thermowell to allow electronic temperature compensation. A second thermowell for reference measurements is available on special request
High Temperature Loading (HTL)	The meters can be delivered in a HTL version following EN1359 PN0,1
Pressure Tapping	This device allows the gas pressure to be measured at a reference point.



Thermowell fitted onto an ACD standard

Totalizer Features

With the CO series, Actaris Gas offers a complete portfolio to address today's and future energy resource and environmental challenges.

"c" series

Smart ready, allowing for future AMR capabilities

Actaris Gas's latest-generation mechanical index meter comes standard with our Cyble™ target, and can be upgraded in the field to implement AMR and enable remote reading via different communication technologies.

- » Smart reading possible with additional modules
- » Can be retrofitted on site without recalibrating the meter
- » Reliable of an electronic switch (no wear or bouncing)
- » Proven, tested design backed by 20 years' experience
- » Protection against magnetic tampering



Building Blocks of Actaris Gas's CO series

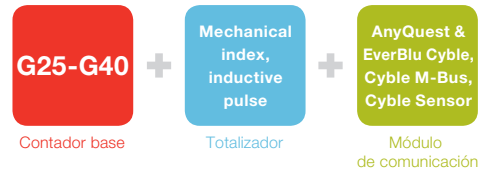

Totalizer characteristics "c" series

Meter Size	G25 / G40
European Metrological Approval (04/22/EC - Module B)	N° DE-10-MI002-PTB004
Display	Mechanical index with 8 drums (2 decimals)
Transmission Rate	0.1 m ³ / rotation
Transmission System	Cyble™ target
Mechanical Environment	M2
Electronical Environment	E2

"o" series

Retrofit enabling smart upgrades to existing meter park

- » The "o" series addresses traditional meters with a mechanical index, already installed in the field, to minimize stranded assets when AMR/AMI is required.

LF transmitters - via a Reed switch - and a Pulse RF radio module transform pulses into transmittable data.



"o" series Totaliser with LF "cable"

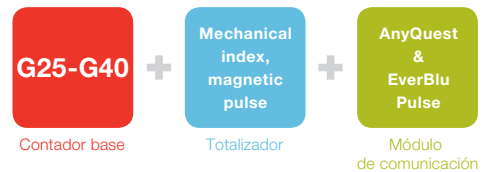

Totalizer characteristics "o" series

Meter Size	G25 / G40
European Metrological Approval (04/22/EC - Module B)	N° DE-10-MI002-PTB004
Display	Mechanical index with 8 drums (2 decimals)
Pulse Generator	Standard 0.1 m ³ / pulse (optional 1 m ³ / pulse)
Pulse Transmitter	Retrofittable LF system, 180 Vdc max – 50 mA max standard 0.1 m ³ /pulse. Different versions: with 1m cable, terminal block or binder plug (Double LF pulse transmitter)
Mechanical Environment	M2
Electronical Environment	E2

Dimensions and Weight

Model	G Size	Qmax m³/h	Qmin m³/h	Cyclic Volume dm³	DN mm	Threads Standard	Pmax bar	Pmax HTL bar	Pressure Loss (Air) mbar	A mm	B mm	C mm	D mm	E mm	F mm	Weight kg
														"c & o" series		"c & o" series

G25: 2 Pipe version

1	G25	40	0.25	20	50	G21/2" A ISO228-1	1	0.1	2.4	335	443	138	457	289	-	13.3
2	G25	40	0.25	20	50	MFIT001	1	0.1	2.4	335	443	138	457	289	-	13.3
3	G25	40	0.25	20	40	G2" A ISO228-1	1	0.1	2.4	335	443	138	457	289	-	13.3
4	G25	40	0.25	20	50	G21/2" A ISO228-1	1	0.1	2.4	400	534	138	457	289	-	13.6

G25: Single Pipe version

5	G25	40	0.25	20	50	ISO PN10	1	0.1	2.4	-	469	138	457	289	-	14.4
---	-----	----	------	----	----	----------	---	-----	-----	---	-----	-----	-----	-----	---	------

G40: 2 Pipe version - vertical drawn

1	G40	65	0.4	30	65	ISO PN10	1	0.1	1.7	430	661	185	612	384	-	42.0
2	G40	65	0.4	30	80	ISO PN10	1	0.1	1.7	430	661	185	612	384	-	42.0
3	G40	65	0.4	30	80	ISO PN10	1	0.1	1.7	500	719	185	612	384	-	41.0
4	G40	65	0.4	30	65	ISO PN10	1	0.1	1.7	510	719	185	612	384	-	41.0
5	G40	65	0.4	30	80	ISO PN10	1	0.1	1.7	510	719	185	612	384	-	41.0

G40: 2 Pipe version - horizontal welded

6	G40	65	0.4	30	65	ISO PN10	0.5	0.1	1.7	570	420	175	494	369	634	52.0
7	G40	65	0.4	30	80	ISO PN10	0.5	0.1	1.7	570	420	175	494	358	634	52.0

G40: Single pipe version

8	G40	65	0.4	30	65	ISO PN10	1	0.1	1.7	-	697	185	612	384	-	46.0
9	G40	65	0.4	30	80	ISO PN10	1	0.1	1.7	-	697	185	612	384	-	46.0

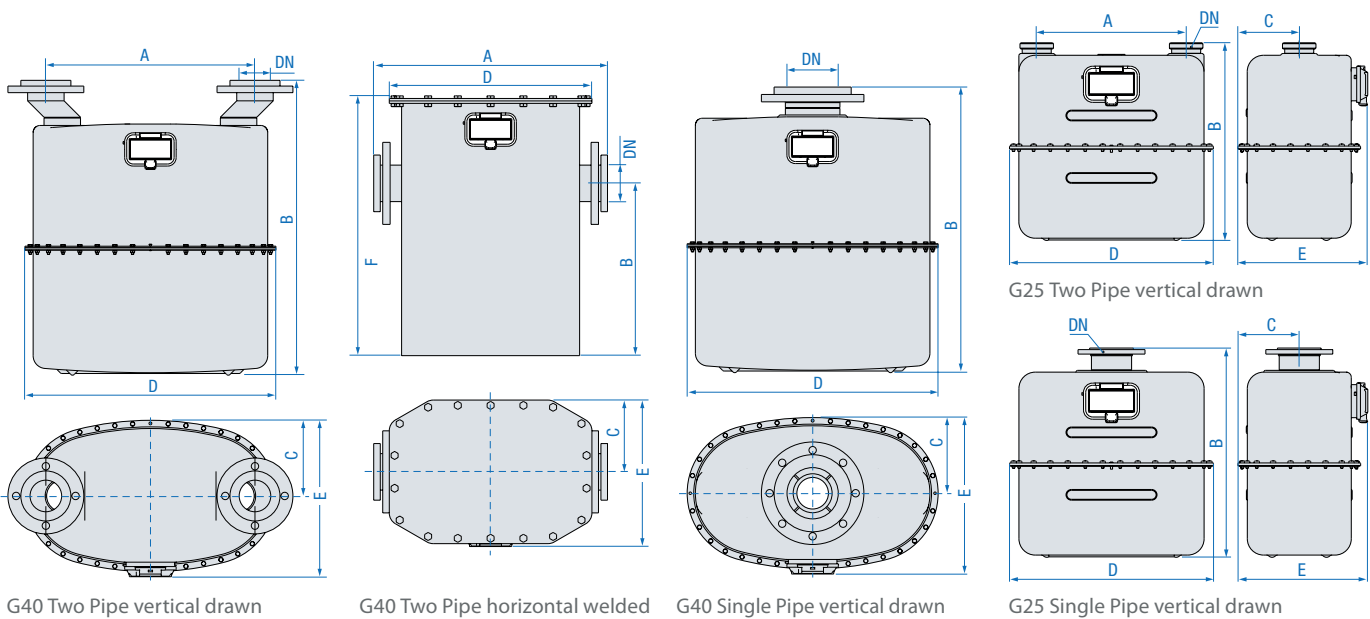

Dresser Utility Solutions GmbH

Hardeckstr. 2
76185 Karlsruhe
T: +49 (0)721 / 5981 - 100
F: +49 (0)721 / 5981 - 282

© 2022 Natural Gas Solutions North America, LLC – All rights reserved. Dresser Utility Solutions reserves the right to make changes in specifications and features shown herein, or discontinue the product described at any time without notice or obligation. Contact your Dresser Utility Solutions representative for the most current information. The Dresser Logo and all Trademarks containing the term "Dresser" are the property of Dresser, LLC, a subsidiary of Baker Hughes.

